



# 3V, SUPER MINIMOLD MEDIUM POWER SI MMIC AMPLIFIER

## UPC2771TB

### FEATURES

- **HIGH GAIN:** 21 dB at 900 to 1500 MHz Typical
- **HIGH OUTPUT POWER:**  $P_{SAT} = +12.5$  dBm at 900 MHz  
+11 dBm at 1500 MHz
- **LOW BIAS VOLTAGE:** 3.0 V Typical, 2.7 V Minimum
- **SUPER SMALL PACKAGE:** SOT-363
- **TAPE AND REEL PACKAGING OPTION AVAILABLE**

### DESCRIPTION

NEC's UPC2771TB is a Silicon Monolithic integrated circuit which is manufactured using the NESAT™ III process. The NESAT III process produces transistors with  $f_T$  approaching 20 GHz. The UPC2771TB is pin compatible and has comparable performance as the larger UPC2771T, so it is suitable for use as a replacement to help reduce system size. The IC is housed in a 6 pin super minimold or SOT-363 package. Operating on a 3 volt supply, this IC is ideally suited for hand-held, portable designs.

NEC's stringent quality assurance and test procedures ensure the highest reliability and performance.

GAIN vs. FREQUENCY AND TEMPERATURE

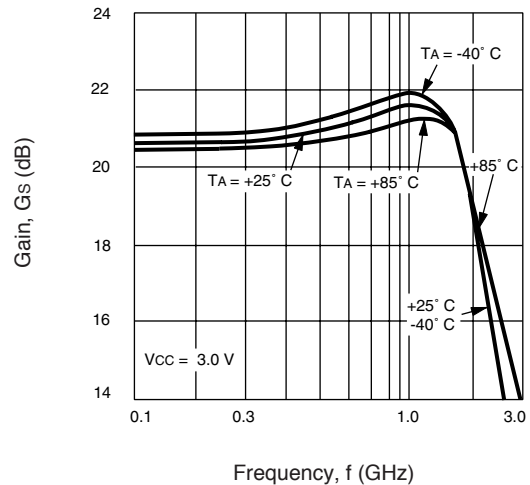

### ELECTRICAL CHARACTERISTICS (TA = 25°C, ZL = ZS = 50 Ω, VCC = 3.0 V)

PART NUMBER PACKAGE OUTLINE			UPC2771TB S06		
SYMBOLS	PARAMETERS AND CONDITIONS	UNITS	MIN	TYP	MAX
I <sub>CC</sub>	Circuit Current (no signal)	mA		36	45
G <sub>S</sub>	Small Signal Gain, f = 900 MHz f = 1500 MHz	dB dB	19 18	21 21	24 24
f <sub>U</sub>	Upper Limit Operating Frequency (The gain at f <sub>U</sub> is 3 dB down from the gain at 100 MHz)	GHz	1.8	2.2	
P <sub>1dB</sub>	1 dB Compressed Output Power, f = 900 MHz f = 1500 MHz	dBm dBm	+9 +7	+11.5 +9.5	
P <sub>SAT</sub>	Saturated Output Power, f = 900 MHz f = 1500 MHz	dBm dBm		+12.5 +11	
NF	Noise Figure, f = 900 MHz f = 1500 MHz	dB dB		6 6	7.5 7.5
RL <sub>IN</sub>	Input Return Loss, f = 900 MHz f = 1500 MHz	dB dB	10 10	14 14	
RL <sub>OUT</sub>	Output Return Loss, f = 900 MHz f = 1500 MHz	dB dB	6.5 5.5	9.0 8.5	
ISOL	Isolation, f = 900 MHz f = 1500 MHz	dB dB	25 25	30 30	
OIP3	SSB Output Third Order Intercept Point f = 900, 902 MHz, P <sub>OUT</sub> = +4 dBm f = 1500, 1502 MHz, P <sub>OUT</sub> = +4 dBm	dBm dBm		+13 +10	
P <sub>ADJ1</sub>	Adjacent Channel Power 1, f = 900 MHz, π/4 QPSK wave <sup>1</sup> , P <sub>OUT</sub> = +7 dBm Δf = ± 50 kHz Δf = ± 100 kHz	dBc dBc		-61 -72	
P <sub>ADJ2</sub>	Adjacent Channel Power 2, f = 1.5 GHz, π/4 QPSK wave <sup>1</sup> , P <sub>OUT</sub> = +7 dBm Δf = ± 50 kHz Δf = ± 100 kHz	dBc dBc		-59 -72	

Note:

1. π/4 QPSK modulated wave input, data rate 42 kbps, Filter roll off α = 0.5

**ABSOLUTE MAXIMUM RATINGS<sup>1</sup>** (T<sub>A</sub> = 25°C)

SYMBOLS	PARAMETERS	UNITS	RATINGS
V <sub>CC</sub>	Supply Voltage	V	3.6
I <sub>CC</sub>	Total Supply Current	mA	77.7
P <sub>IN</sub>	Input Power	dBm	+13
P <sub>T</sub>	Total Power Dissipation <sup>2</sup>	mW	200
T <sub>OP</sub>	Operating Temperature	°C	-40 to +85
T <sub>STG</sub>	Storage Temperature	°C	-55 to +150

Notes:

1. Operation in excess of any one of these parameters may result in permanent damage.
2. Mounted on a 50 X 50 X 1.6 mm epoxy glass PWB (T<sub>A</sub> = 85°C).

**RECOMMENDED OPERATING CONDITIONS**

SYMBOLS	PARAMETERS	UNITS	MIN	TYP	MAX
V <sub>CC</sub>	Supply Voltage	V	2.7	3	3.3
T <sub>OP</sub>	Operating Temperature	°C	-40	+25	+85

**TYPICAL PERFORMANCE CURVES** (T<sub>A</sub> = 25°C)

**TEST CIRCUIT**

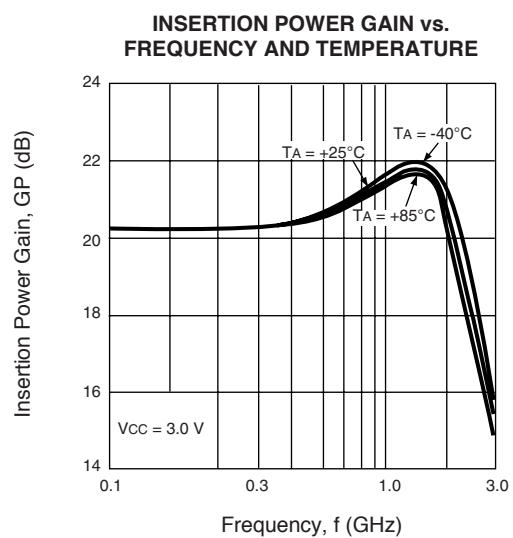
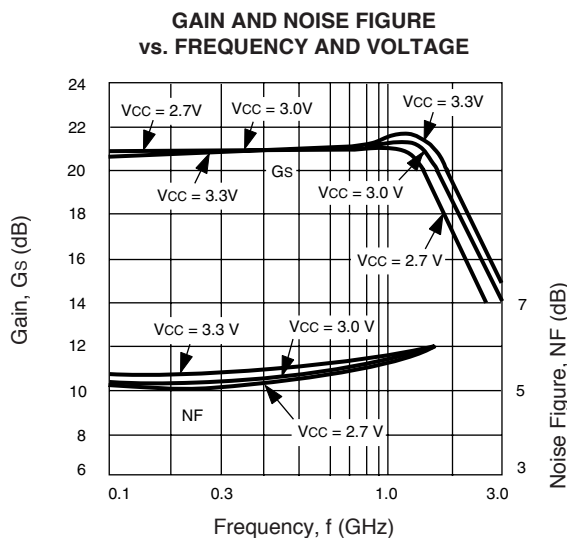
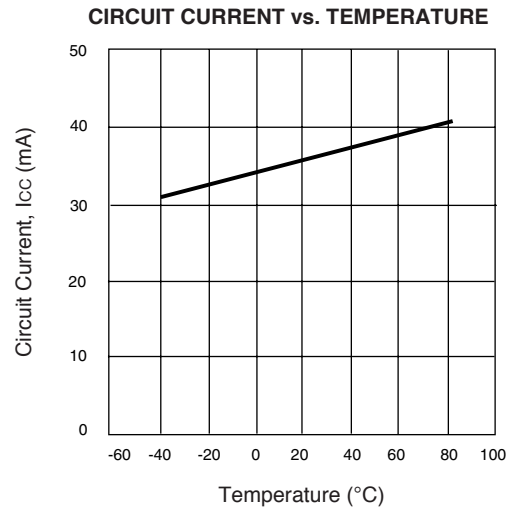
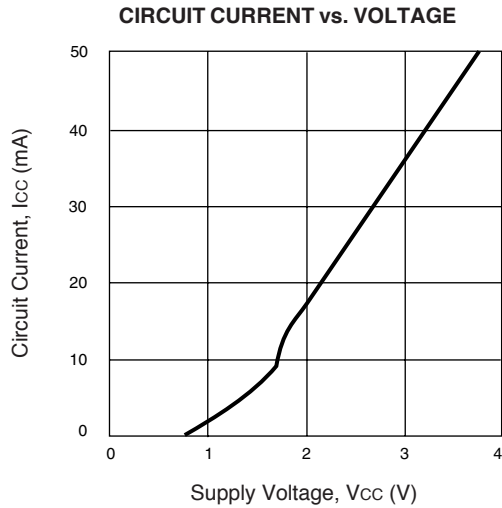
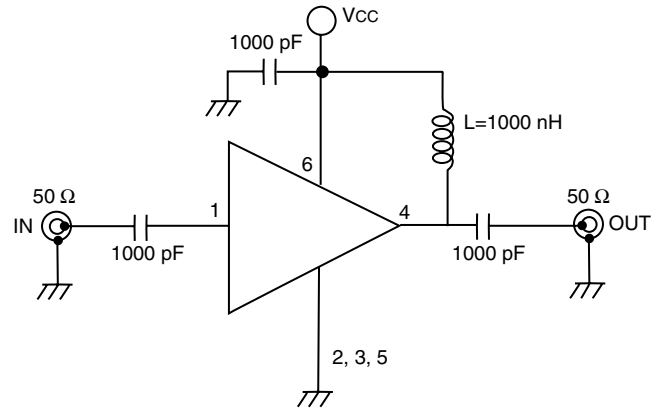

**TYPICAL PERFORMANCE CURVES** ( $T_A = 25^\circ$ )

**INPUT RETURN LOSS AND OUTPUT RETURN LOSS vs. FREQUENCY**

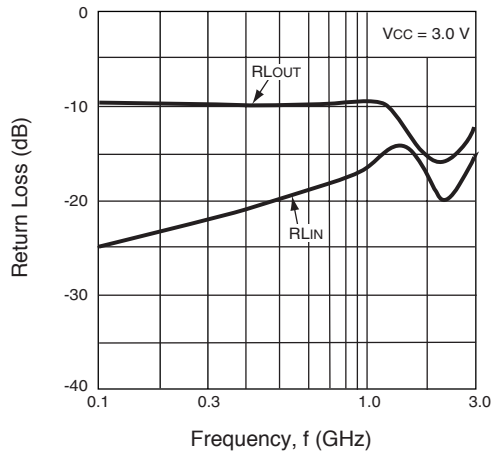

**ISOLATION vs. FREQUENCY**

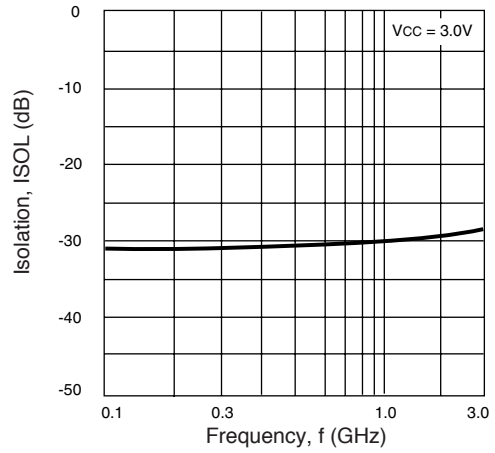

**OUTPUT POWER vs. INPUT POWER AND VOLTAGE**

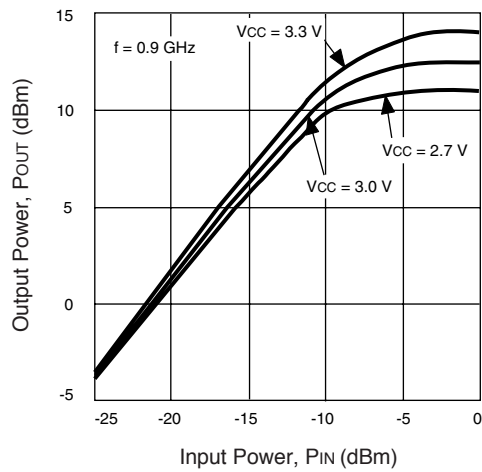

**OUTPUT POWER vs. INPUT POWER AND TEMPERATURE**

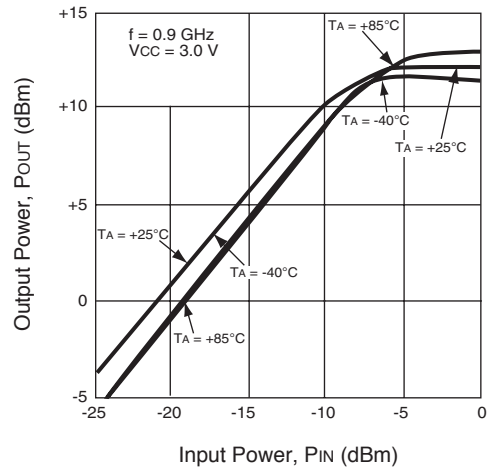

**OUTPUT POWER vs. INPUT POWER AND VOLTAGE**

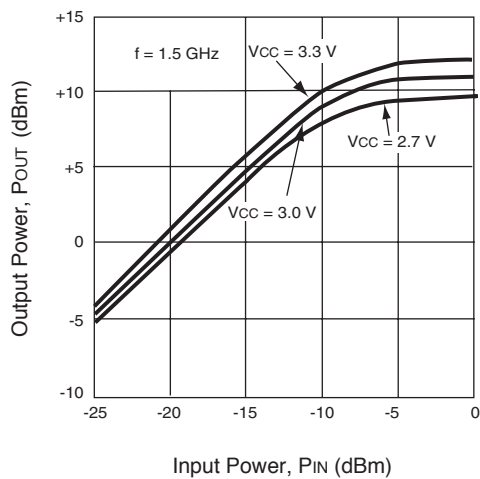

**OUTPUT POWER vs. INPUT POWER AND TEMPERATURE**

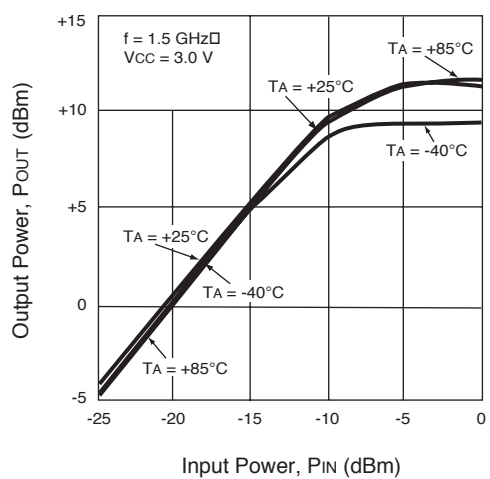

**OUTPUT POWER vs. INPUT POWER AND VOLTAGE**

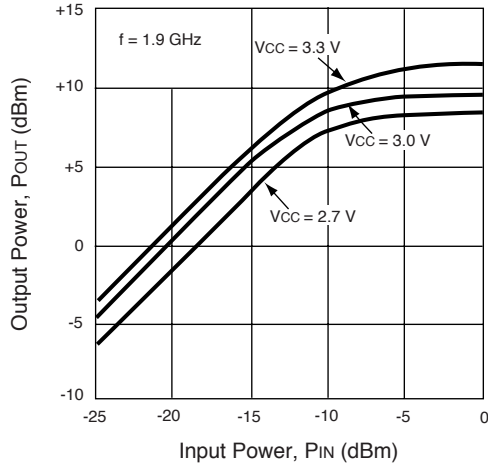

**OUTPUT POWER vs. INPUT POWER AND VOLTAGE**

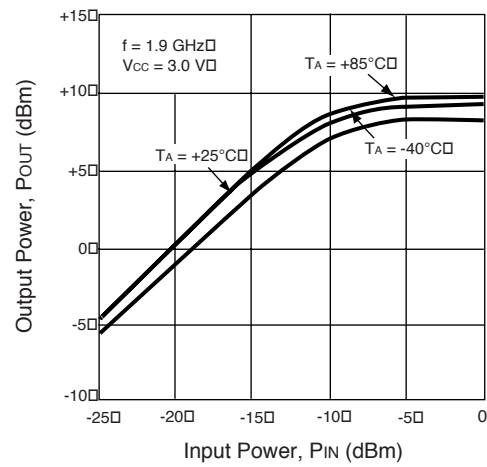

**SATURATED OUTPUT POWER vs. FREQUENCY AND VOLTAGE**

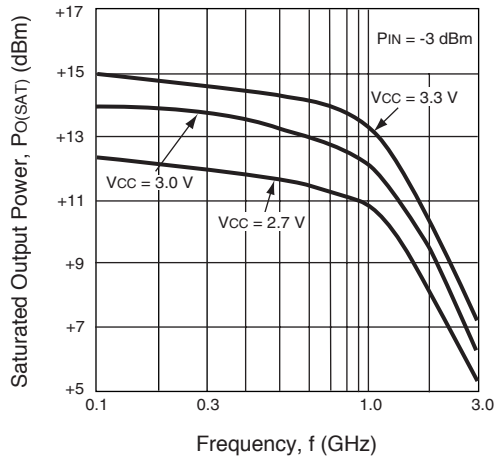

**SATURATED OUTPUT POWER vs. FREQUENCY AND TEMPERATURE**

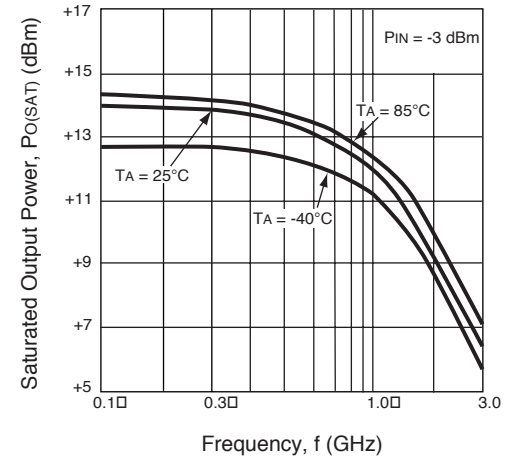

**THIRD ORDER INTERMODULATION DISTORTION vs. OUTPUT POWER OF EACH TONE AND VOLTAGE**

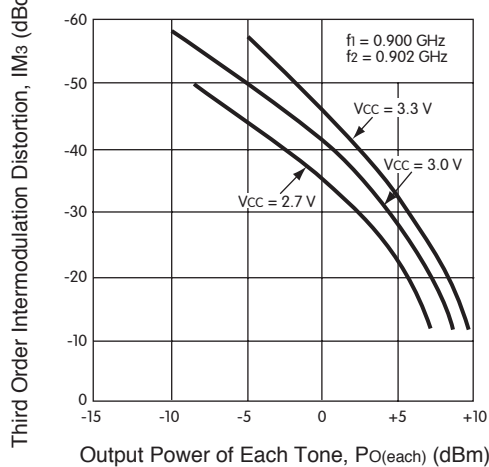

**THIRD ORDER INTERMODULATION DISTORTION vs. OUTPUT POWER OF EACH TONE AND VOLTAGE**

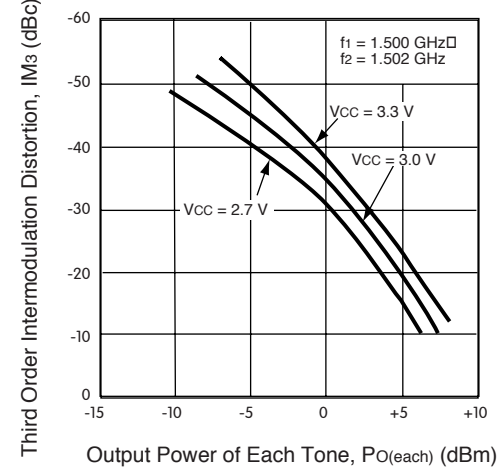

**TYPICAL SCATTERING PARAMETERS** (TA = 25°C)

S11 Frequency

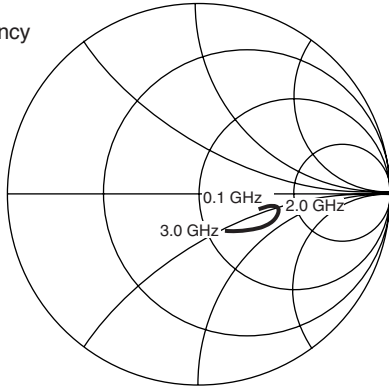

S22 Frequency

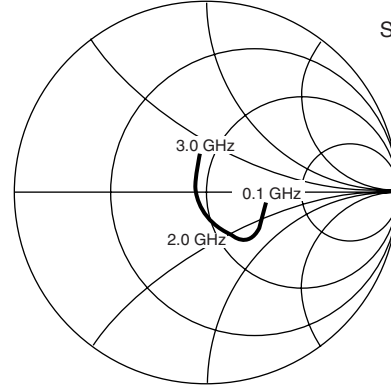

Vcc = Vout = 3.0 V, Icc = 35 mA

FREQUENCY GHz	S11		S21		S12		S22		K
	MAG	ANG	MAG	ANG	MAG	ANG	MAG	ANG	
0.1	0.045	19.7	10.570	-4.7	0.028	0.8	0.327	-6.2	1.65
0.2	0.057	37.0	10.638	-9.5	0.028	5.0	0.325	-11.5	1.63
0.3	0.075	41.3	10.775	-14.1	0.029	8.6	0.323	-16.2	1.58
0.4	0.090	43.3	11.004	-19.4	0.030	11.1	0.326	-20.9	1.49
0.5	0.105	42.2	11.275	-24.4	0.030	14.9	0.331	-26.4	1.45
0.6	0.118	40.2	11.586	-30.0	0.031	15.8	0.342	-32.0	1.37
0.7	0.138	34.9	12.041	-35.9	0.031	19.8	0.350	-37.3	1.29
0.8	0.163	32.5	12.367	-42.1	0.032	20.1	0.359	-42.8	1.20
0.9	0.186	29.4	12.844	-48.8	0.032	23.2	0.361	-49.4	1.15
1.0	0.202	26.3	13.300	-56.6	0.032	23.9	0.371	-56.1	1.11
1.1	0.219	21.7	13.771	-64.6	0.033	24.9	0.389	-62.5	1.03
1.2	0.233	15.4	14.082	-73.5	0.033	26.6	0.400	-69.3	0.99
1.3	0.252	8.4	14.365	-83.2	0.036	28.8	0.405	-75.4	0.92
1.4	0.267	-0.1	14.336	-92.6	0.036	30.0	0.402	-83.6	0.91
1.5	0.285	-6.8	14.142	-102.4	0.036	32.0	0.406	-91.6	0.90
1.6	0.293	-13.9	13.929	-112.0	0.037	31.6	0.413	-99.3	0.89
1.7	0.304	-20.9	13.428	-121.6	0.039	32.5	0.414	-105.8	0.88
1.8	0.290	-28.1	12.722	-131.0	0.038	34.7	0.401	-113.7	0.96
1.9	0.285	-35.3	11.966	-139.6	0.038	36.1	0.387	-120.8	1.03
2.0	0.273	-41.8	11.232	-147.5	0.038	37.4	0.378	-127.6	1.09
2.1	0.267	-47.4	10.500	-154.8	0.039	39.1	0.366	-133.1	1.14
2.2	0.254	-51.6	9.815	-161.7	0.040	41.4	0.356	-138.0	1.20
2.3	0.237	-57.1	9.168	-168.0	0.041	43.7	0.342	-142.8	1.28
2.4	0.221	-61.1	8.570	-173.7	0.041	48.3	0.325	-148.3	1.37
2.5	0.212	-68.8	7.967	-179.7	0.042	48.3	0.322	-152.6	1.44
2.6	0.208	-72.2	7.507	-174.9	0.043	50.8	0.314	-156.7	1.49
2.7	0.202	-74.1	7.004	-170.0	0.045	53.7	0.309	-160.1	1.53
2.8	0.190	-76.3	6.667	-164.7	0.047	54.2	0.303	-164.0	1.56
2.9	0.178	-76.7	6.336	-160.7	0.051	57.7	0.292	-167.8	1.55
3.0	0.154	-82.3	6.003	-155.6	0.051	56.5	0.287	-172.8	1.62
3.1	0.147	-88.0	5.772	-151.3	0.054	59.3	0.279	-176.4	1.61

**OUTLINE DIMENSIONS** (Units in mm)

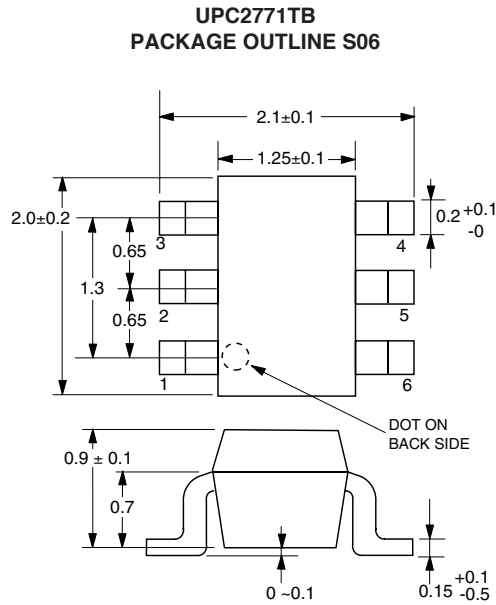

**LEAD CONNECTIONS**

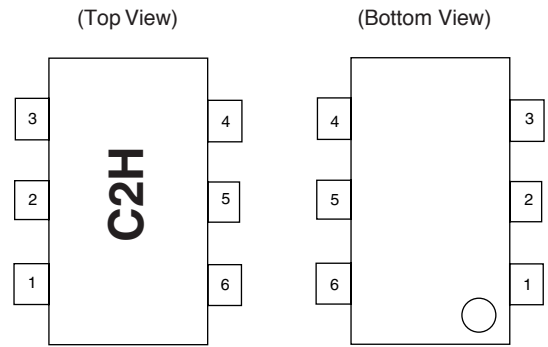

- 1. INPUT
- 2. GND
- 3. GND
- 4. OUTPUT
- 5. GND
- 6. Vcc

**PIN DESCRIPTION**

Pin No.	Pin Name (V)	Applied Voltage	Description	Internal Equivalent Circuit
1	Input	—	Signal input pin. An internal matching circuit, configured with resistors, enables 50 Ω connection over a wide bandwidth. A multi-feedback circuit is designed to cancel the deviations of h <sub>FE</sub> and resistance. This pin must be coupled to the signal source with a blocking capacitor.	
4	Output	2.7 to 3.3	Signal output pin. Connect an inductor between this pin and VCC to supply current to the internal output transistors.	
6	VCC		Power supply pin. This pin should be externally equipped with a bypass capacitor to minimize ground impedance.	
2	GND	0	Ground pins. These pins should be connected to system ground with minimum inductance. Ground pattern on the board should be formed as wide as possible. All the ground pins must be connected together with wide ground pattern to minimize impedance difference.	

**ORDERING INFORMATION**

PART NUMBER	QTY
UPC2771TB-E3-A	3K/Reel

Note: Embossed Tape, 8 mm wide. Pins 1, 2 and 3 face perforated side of tape.

Life Support Applications

These NEC products are not intended for use in life support devices, appliances, or systems where the malfunction of these products can reasonably be expected to result in personal injury. The customers of CEL using or selling these products for use in such applications do so at their own risk and agree to fully indemnify CEL for all damages resulting from such improper use or sale.

EXCLUSIVE NORTH AMERICAN AGENT FOR **NEC** RF, MICROWAVE & OPTOELECTRONIC SEMICONDUCTORS

**CEL CALIFORNIA EASTERN LABORATORIES** • Headquarters • 4590 Patrick Henry Drive • Santa Clara, CA 95054-1817 • (408) 988-3500 • Telex 34-6393 • FAX (408) 988-0279  
24-Hour Fax-On-Demand: 800-390-3232 (U.S. and Canada only) • Internet: <http://WWW.CEL.COM>

Subject: Compliance with EU Directives

CEL certifies, to its knowledge, that semiconductor and laser products detailed below are compliant with the requirements of European Union (EU) Directive 2002/95/EC Restriction on Use of Hazardous Substances in electrical and electronic equipment (RoHS) and the requirements of EU Directive 2003/11/EC Restriction on Penta and Octa BDE.

CEL Pb-free products have the same base part number with a suffix added. The suffix –A indicates that the device is Pb-free. The –AZ suffix is used to designate devices containing Pb which are exempted from the requirement of RoHS directive (\*). In all cases the devices have Pb-free terminals. All devices with these suffixes meet the requirements of the RoHS directive.

This status is based on CEL’s understanding of the EU Directives and knowledge of the materials that go into its products as of the date of disclosure of this information.

Restricted Substance per RoHS	Concentration Limit per RoHS (values are not yet fixed)	Concentration contained in CEL devices	
		-A	-AZ
Lead (Pb)	< 1000 PPM	Not Detected	(*)
Mercury	< 1000 PPM	Not Detected	
Cadmium	< 100 PPM	Not Detected	
Hexavalent Chromium	< 1000 PPM	Not Detected	
PBB	< 1000 PPM	Not Detected	
PBDE	< 1000 PPM	Not Detected	

If you should have any additional questions regarding our devices and compliance to environmental standards, please do not hesitate to contact your local representative.

**Important Information and Disclaimer:** Information provided by CEL on its website or in other communications concerning the substance content of its products represents knowledge and belief as of the date that it is provided. CEL bases its knowledge and belief on information provided by third parties and makes no representation or warranty as to the accuracy of such information. Efforts are underway to better integrate information from third parties. CEL has taken and continues to take reasonable steps to provide representative and accurate information but may not have conducted destructive testing or chemical analysis on incoming materials and chemicals. CEL and CEL suppliers consider certain information to be proprietary, and thus CAS numbers and other limited information may not be available for release.

In no event shall CEL’s liability arising out of such information exceed the total purchase price of the CEL part(s) at issue sold by CEL to customer on an annual basis.

See CEL Terms and Conditions for additional clarification of warranties and liability.